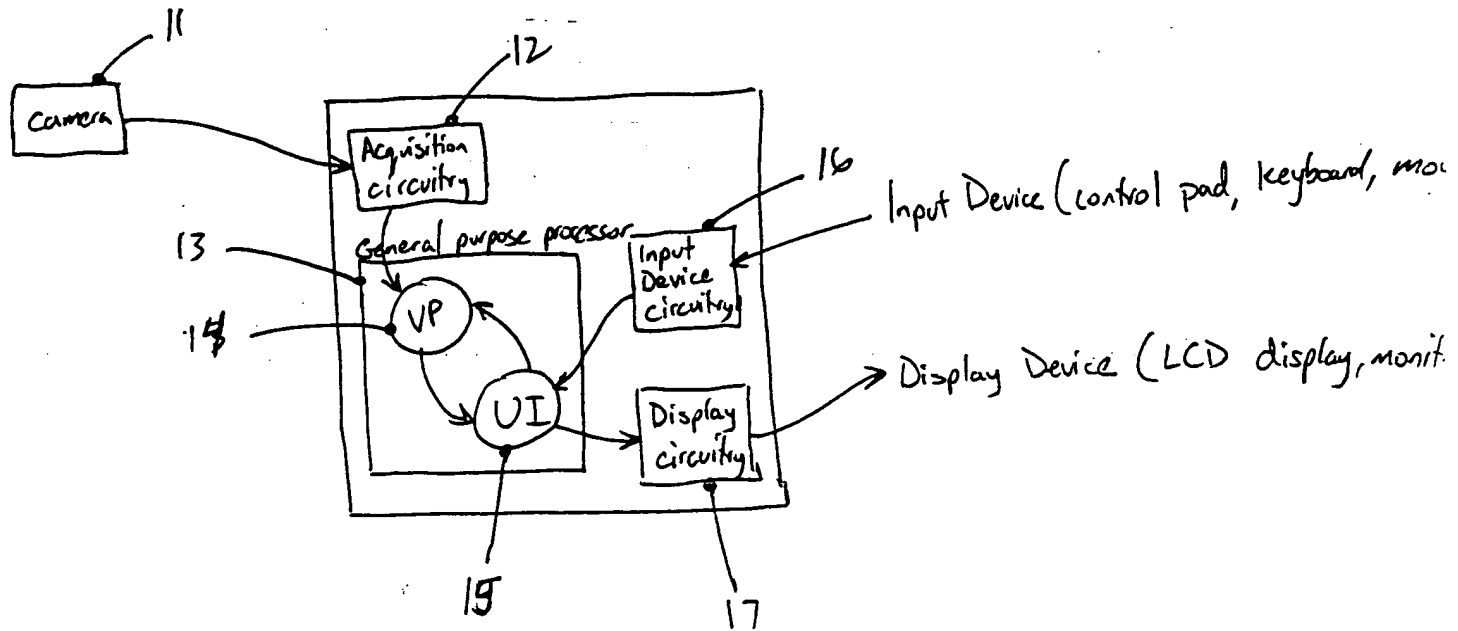

FIG 1

single computer vision system



PRIOR ART

09873163.050201

FIG 2

Computer vision system

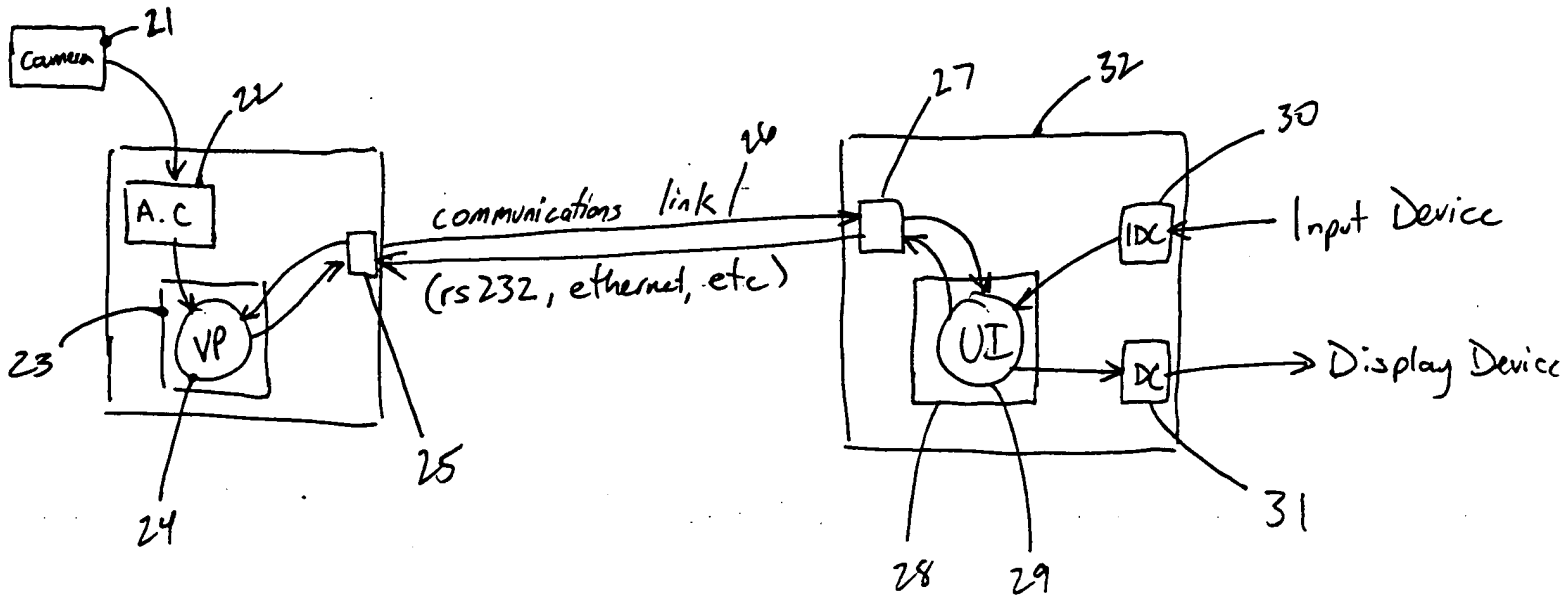

PRIOR ART

09873163.050201

FIG 3 UI connecting to many VPs via a network

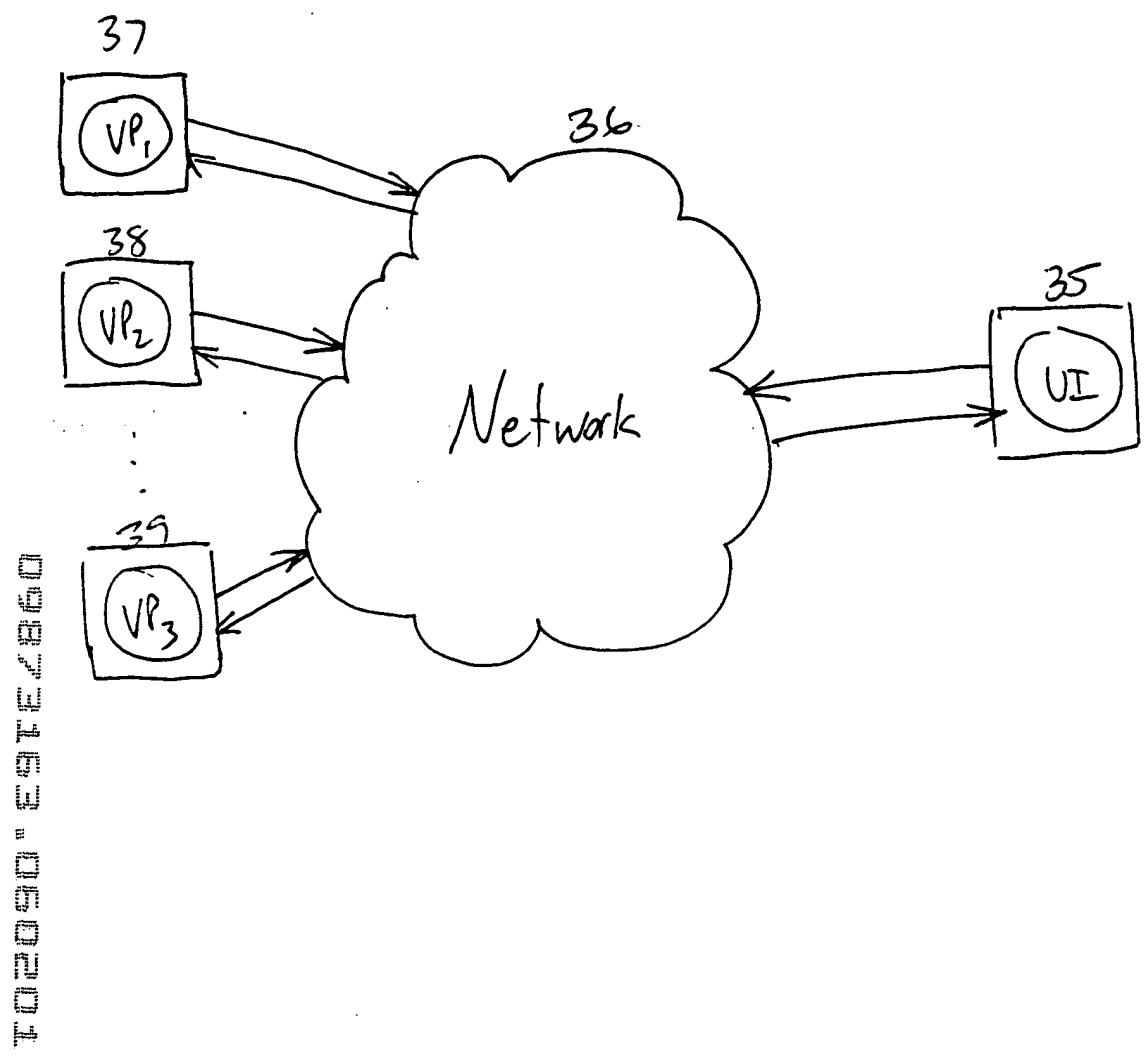
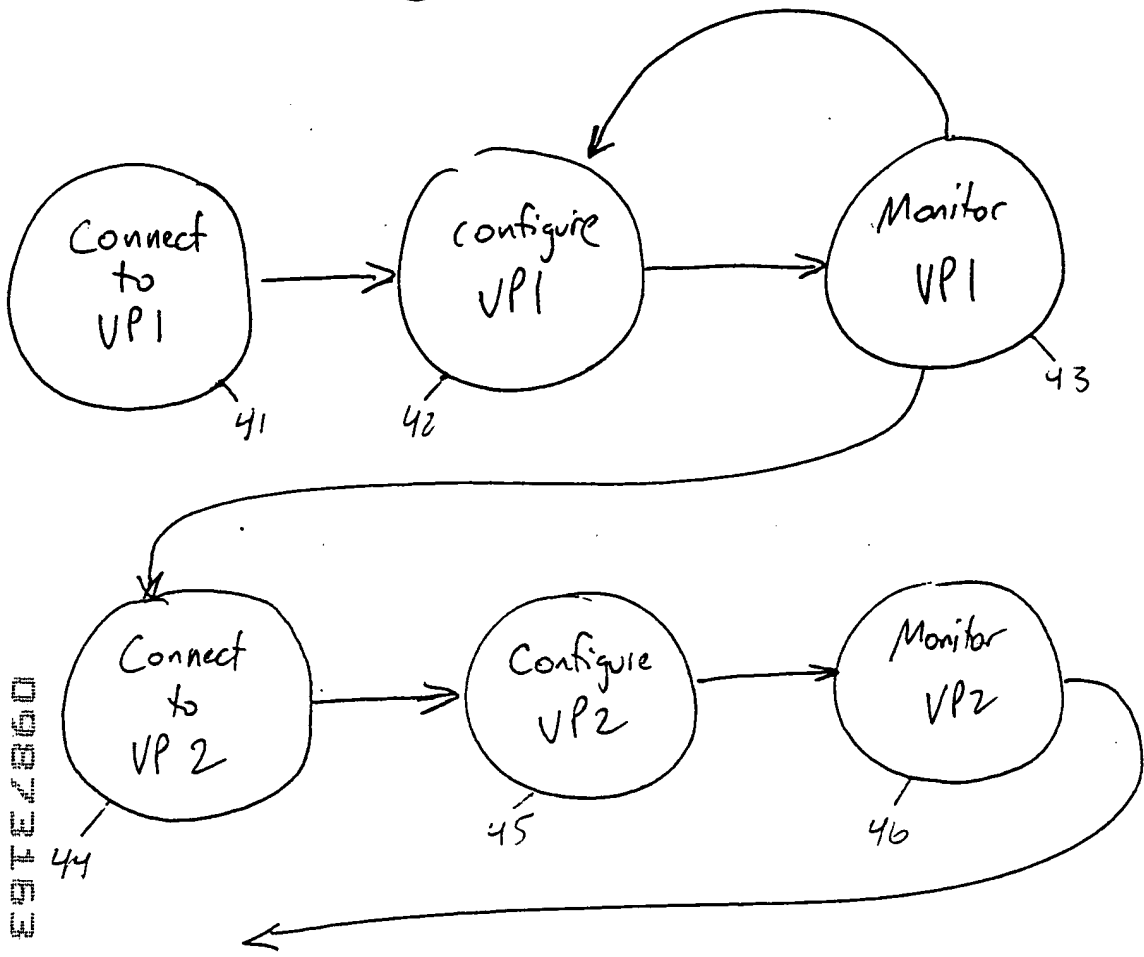

FIG 4

Connection, configuration, and monitoring by a developer





002090*E9TEZ860

PRIOR ART

51

A3= ListBox("name0","name1","name2")

	A	B	C	D	E	F	G	H	I
0	 Image		52						
1									
2	<input type="checkbox"/> select		53						
3	 name0								
4	name1								
5	name2								
6									
7									
8									
9									
10									
11									
12									
13									
14									
15									
16									
17									
18									
19									

is3k000018 Local

Offline

0987453 060201

FIG 5

controls.bmp

A2= Link("Link to System1", "System1", "", "")

	Parameter	Value
0	Label	"Link to System1"
1	Host Name	▶ System1
2	Dialog Label	
3	Cursor Pos	

OK Cancel

A text string ... to a text string. Labels are displayed on the ...

FIG 6

link1.bmp

71

A2= Link("Link to System1", "System1", "", "")

	A	B	C	D	E	F	G	H	I
0	Image								
1									
2	Link to System1								
3									
4									
5									
6									
7									
8									
9									
10									
11									
12									
13									
14									
15									
16									
17									
18									
19									

GO-TITANS Local Offline

09873153.060201

FIG 7

link2.bmp

FIG 8

a)

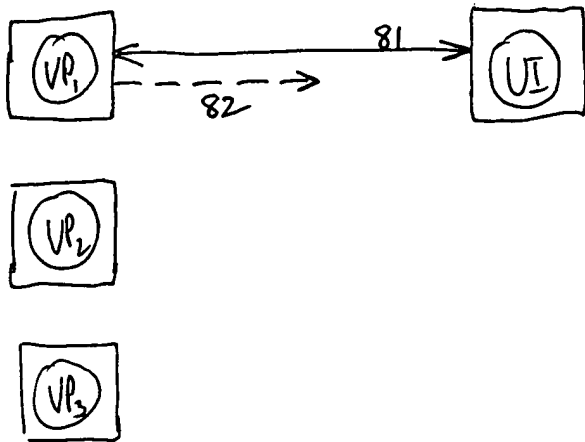

b) TOPOLOGICAL SORTING

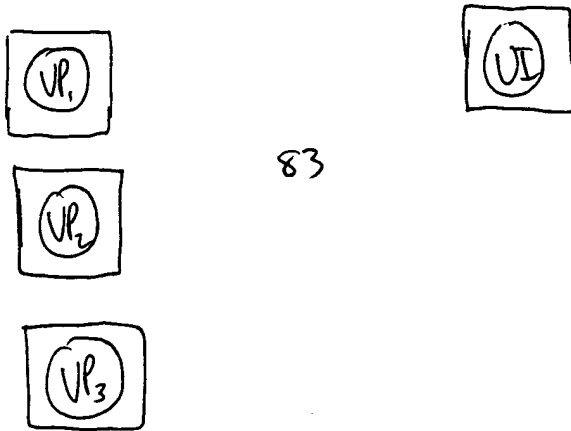

c)

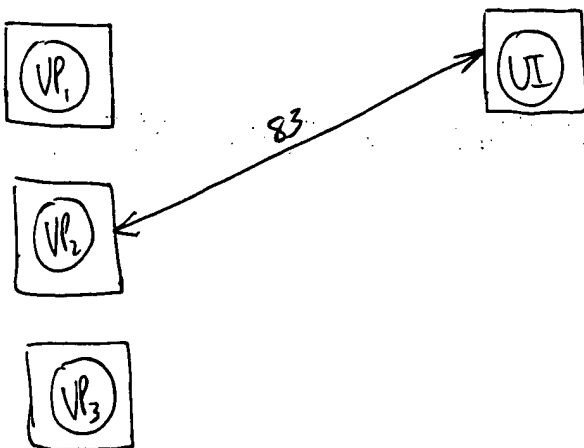

09873163 060201

```
Acquire Image (...)  
if (ReadBarcode fails)  
Link ("FailureSystem")  
else  
  ...  
  <additional VP functions>  
  ...
```

FIG 9